

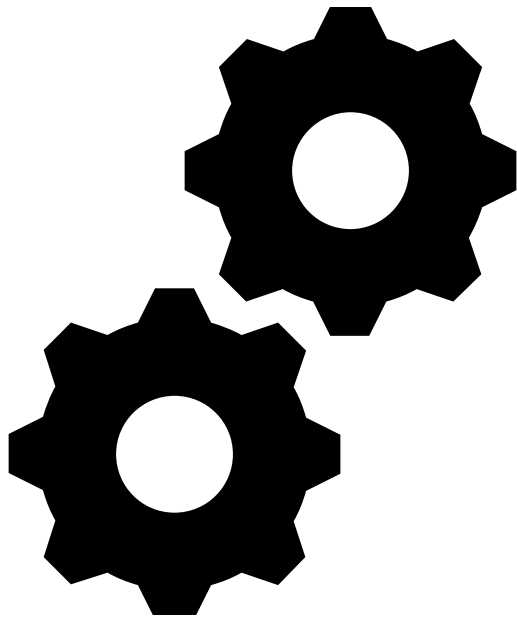

American
Gear Manufacturers
Association



ISO Introduction

Amir Aboutaleb
Vice President, Technical Division
AGMA
Manager of ISO TC 60
June 2019



Topics to Cover

ISO Overview

Committee Participation

ISO Document Types

Information Specific to TC 60

Committee Operations



Topics to Cover

ISO Overview

Committee Participation

ISO Document Types

Information Specific to TC 60

Committee Operations



What is ISO?

Started in 1946 by delegates from 25 countries meeting at the Institute of Civil Engineers in London to:

.....create a new international organization 'to facilitate the international coordination and unification of industrial standards'.

International Standardization Organization, ISO, officially began on 23 February 1947.

Today;

- 164 member countries
- More than 300 technical committees
- More than 22 000 International Standards published
- 100 new standards each month
- ISO standards are everywhere...

120 Member bodies

40 Correspondent members

4 Subscriber members



What is ISO? Continued

- ISO is the International Organization for Standardization
- ISO is an independent, non-governmental organization
- ISO is a global network of national standards bodies with one member per country
- ISO makes International Standards
- ISO is coordinated by a Central Secretariat in Geneva, Switzerland
- ISO is not for profit: selling standards allows ISO to finance their development in a neutral environment, to maintain them and to make new ones

120 Member bodies 10 Correspondent members 4 Subscriber members



Where is ISO?

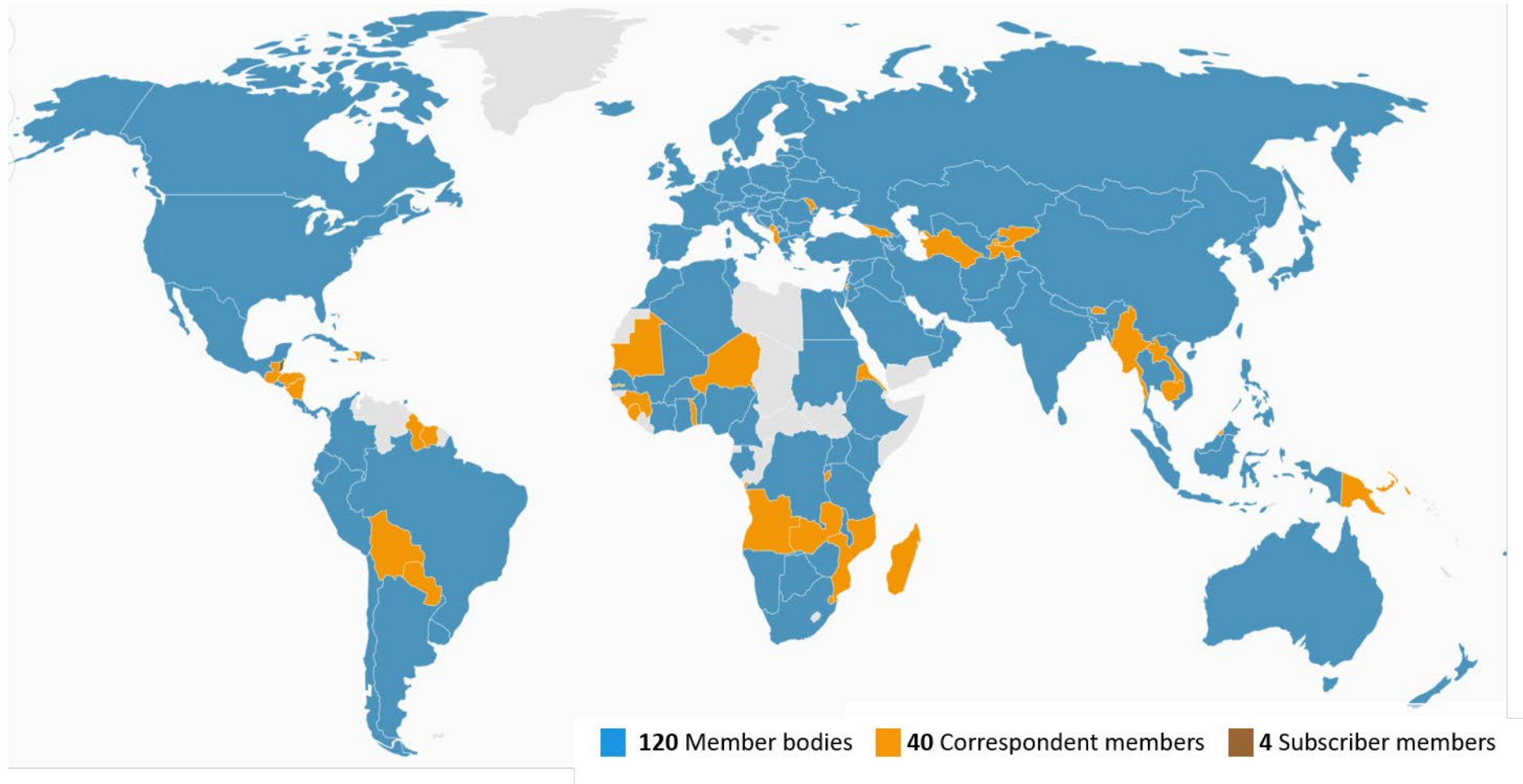

As of May 2019. Source: <https://www.iso.org/members.html>





- Countries are members of ISO not individuals or companies
- There are three membership categories;
 - Full members
 - Correspondence members
 - Subscriber members.

	Subscriber members	Correspondent members	Full members
Participating in developing International Standards	Yes	Yes	Yes
Participating in developing policy	No	Yes	Yes
Selling ISO standards and publications, using copyright and the ISO name and logo	No	Yes	Yes
Participating in governing ISO	No	No	Yes



The ISO System

- ISO standards respond to a **need** in the market
- ISO standards are based on **global** expert opinion
- ISO standards are developed through a **multi-stakeholder** process
- ISO standards are based on a **consensus**



International Standards help all economies thrive!

- Link to global supply chains
- Underpin international trade - access to markets
- **Reduce technical barriers** - support multilateral trade
- **Assure consistent health, safety and performance**
- Help renew confidence and promote economic recovery



Topics to Cover

ISO Overview

Committee Participation

ISO Document Types

Information Specific to TC 60

Committee Operations





How to join a Technical Committee, (TC)

- Search the ISO website for relevant TCs
- Inform your country's Standards Developing Organization, (SDO), of your desire to participate
- Your SDO will contact the relevant TC at ISO
- **Do not contact ISO directly**



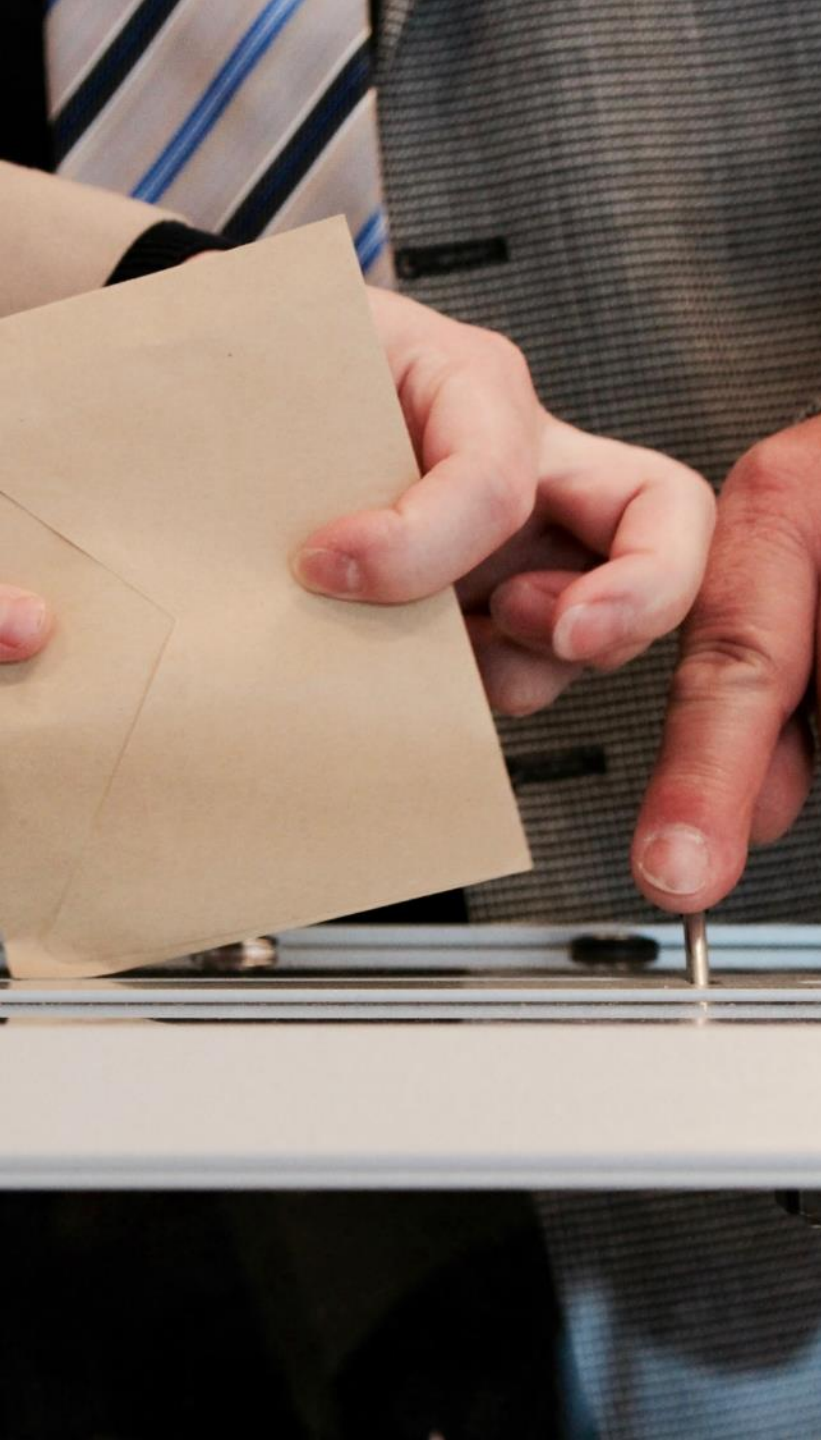

Membership Types

- Participant Member (P-member)
- Observer Member (O-member)
- Liaison Member





Membership Types: Participant Member

- Member bodies that want to play an active role
- Have obligation to vote
- Also identify experts to contribute
- Provide national delegations
- Stakeholders engagement





Membership Types: Observer Member

- Follow developments of projects
- Make contributions
- Not ready / unable to commit
- Open to ISO Member bodies



Membership Types: Liaison Member

- For international & regional organizations
- Participation or information
- Helps to ensure wider acceptance
- Do not have a vote
- Liaison bring expertise



Topics to Cover

ISO Overview

Committee Participation

ISO Document Types

Information Specific to TC 60

Committee Operations



Document Types: (Deliverables)

- International Standard, (IS)
- Technical Specification, (TS)
- Publicly Available Specification, (PAS)
- Technical Report, (TR)



Document Types:

International Standard

- May be normative (requirements) or informative (recommendations) or a mix of both.
- Requires a New Project (NP) ballot
- High level consensus (2/3rd majority, all ISO Full members)
- Review every 5 years, no max life



Document Types:

TS, PAS, TR

Technical Specification - TS	Publicly Available Specification - PAS	Technical Report - TR
Normative NWIP to start	Normative NWIP to start	Informative No requirements A resolution to start
Consensus in a committee	Consensus in a WG	Consensus in a committee
2/3 majority of P-members voting for publication	Simple majority of P-members voting for publication	Simple majority of P-members for publication
Good when you can't get to an IS	Good when you can't get to an IS	Good when TC has collected relevant information e.g. test results
Review after 3 years Max life = 6 years (recommended)	Review after 3 years Maximum life = 6 years	No life limit



Topics to Cover

ISO Overview

Committee Participation

ISO Document Types

Information Specific to TC 60

Committee Operations



ISO/TC 60 within ISO

- There are over 300 Technical Committees, (TC) within ISO, such as:
- TC 1 Screw threads
- TC 4 Rolling bearings
- TC 39 Machine tools
- TC 55 Sawn timber and sawlogs
- **TC 60 Gears**
- TC 162 Doors and windows
- TC 176 Quality assurance ([ISO 9000](#))
- TC 217 Cosmetics
- TC 300 Solid Recovered Fuels



ISO/TC 60 Members

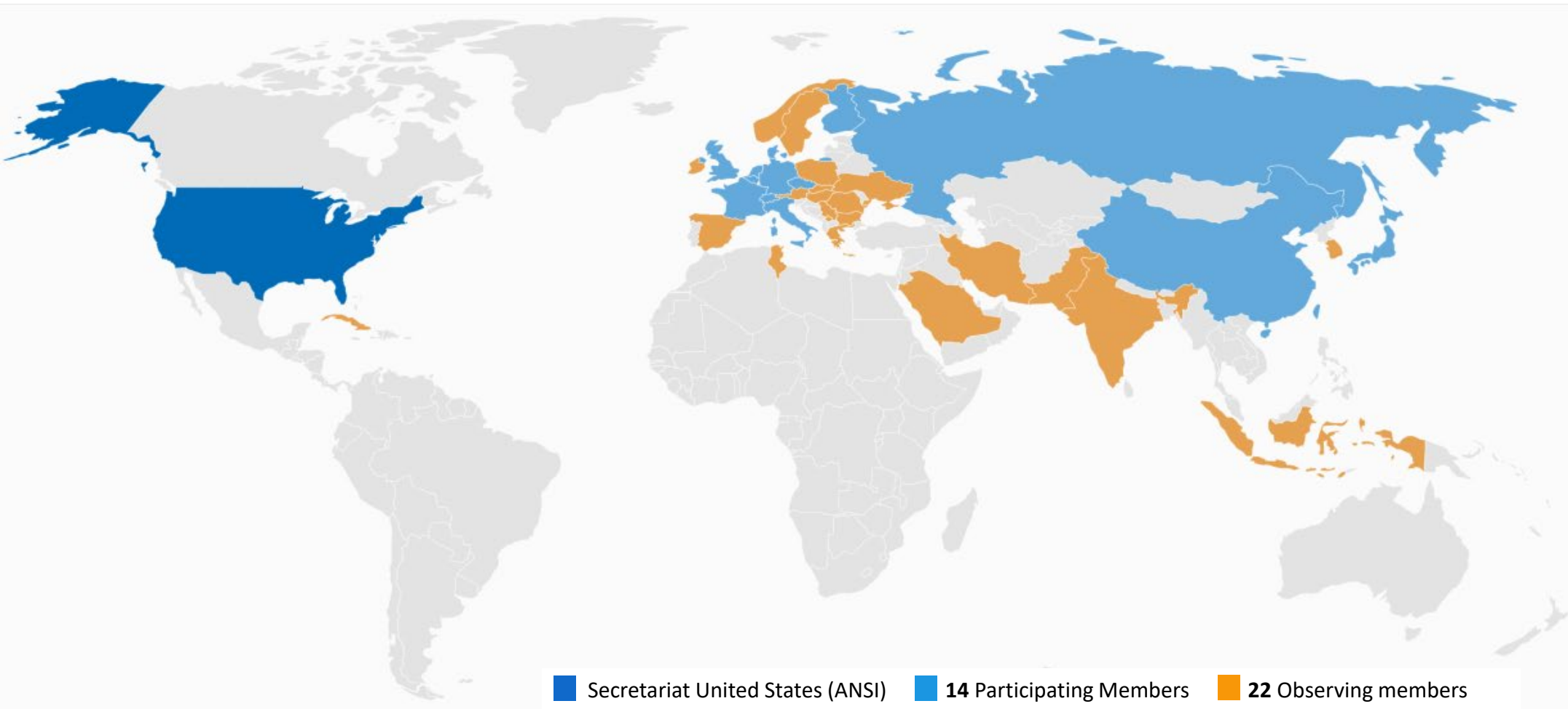

As of May 2019. Source: <https://www.iso.org/committee/49212.html?view=participation>



ISO/TC 60 on the Internet:

<https://www.iso.org/committee/49212.html>

ISO/TC 60

Gears

About

Secretariat: ANSI

👤 Secretary: [Mr Amir Aboutaleb](#)

👤 Chairperson (until end 2024): [Mr Terrance Klaves](#)

👤 ISO Technical Programme Manager 📍 : [Mr Charles-Pierre Bazin de Caix](#)

👤 ISO Editorial Programme Manager 📍 : [Mrs Yvonne Chen](#)

Creation date: 1947

Scope

Standardization in the field of gears, including terminology, nominal dimensions, tolerances, and tools for manufacturing and control.

Quick links

🔗 [Work programme](#)

Drafts and new work items

🔗 [Business plans](#)

TC Business plans for public review

🔗 [Working area](#)

on ISOTC and Public information folder

🔗 [ISO Electronic applications](#)

IT Tools that help support the standards development process

64

published ISO standards *
related to the TC and its SCs

of which 21 under the direct
responsibility of ISO/TC 60

8

ISO standards under
development *
related to the TC and its SCs

of which 2 under the direct
responsibility of ISO/TC 60

14

Participating members

22

Observing members



ISO/TC 60 Organizational Chart

1 Technical Committee
2 Sub-committees
11 Working Groups

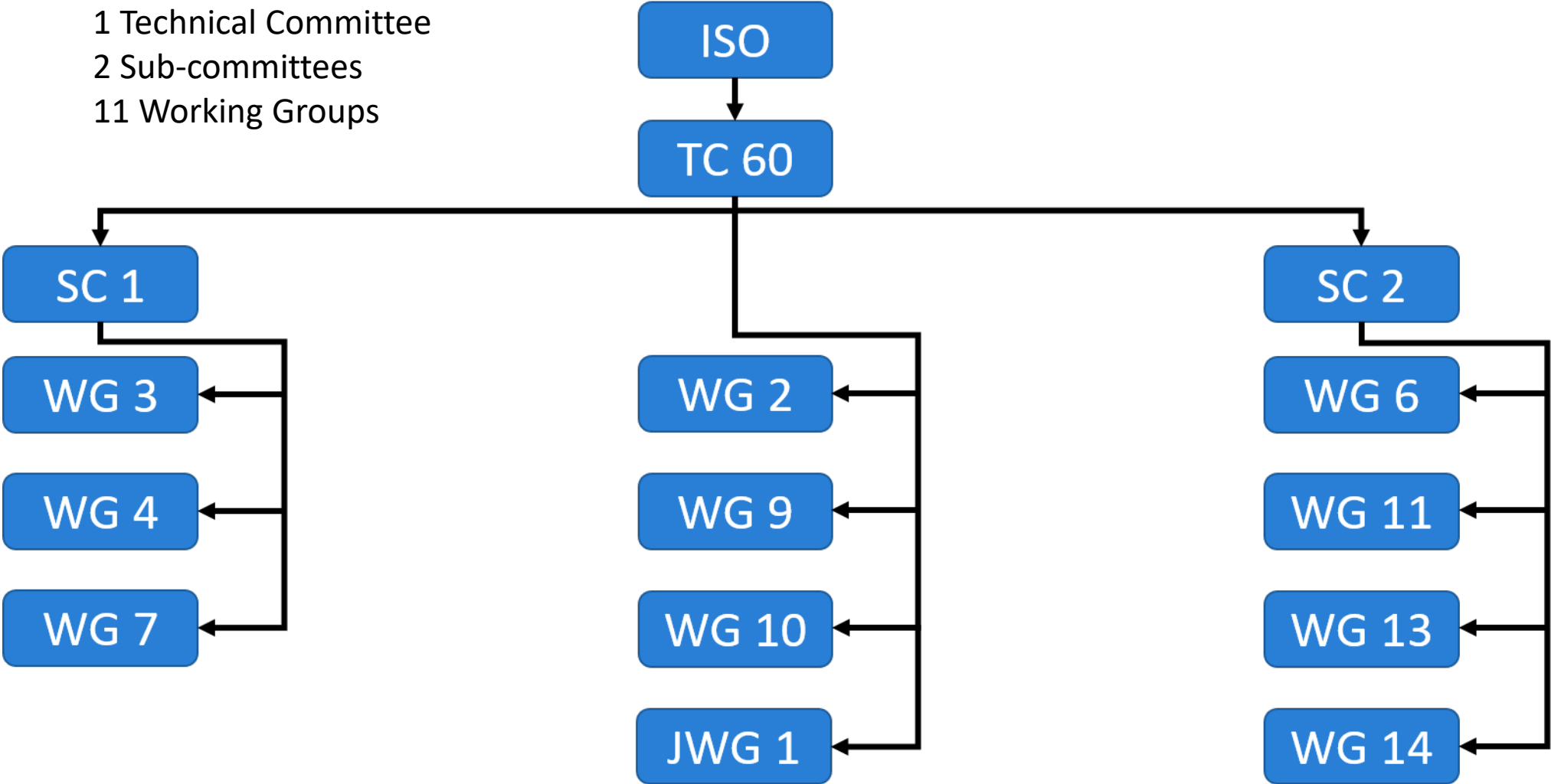

ISO/TC 60 Organizational Chart

- **TC 60** – (Technical Committee) **Secretary: United States**

- **WG 2** – (Working Group 2) **Accuracy of Gears, Convener: USA**

- **WG 9** – (Working Group 9) **Sound and Vibration, *in hibernation***

- **WG 10** – (Working Group 10) **Enclosed Drives, *in hibernation***

- **SC 1** – (Sub Committee 1) **Secretary: United Kingdom**

- **JWG 1** – (Joint Working Group 1) **Wind Turbine Gearboxes, *in hibernation***

- **WG 3** – (Working Group 3) **Gear Cutting Tools, Convener: USA**

- **WG 4** – (Working Group 4) **Terminology & Notation of Gears, Convener: USA**

- **WG 7** – (Working Group 7) **Wormgearing, Convener: France**

- **SC 2** – (Sub Committee 2) **Secretary: Germany**

- **WG 6** – (Working Group 6) **Gear Calculations, Convener: Germany**

- **WG 11** – (Working Group 11) **High Speed Enclosed Gear Units, *in hibernation***

- **WG 13** – (Working Group 13) **Bevel Gears, Convener: Germany**

- **WG 14** – (Working Group 14) **Strength & Quality of Materials, Convener: Germany**



Topics to Cover

ISO Overview

Committee Participation

ISO Document Types

Information Specific to TC 60

Committee Operations



Committee Operations

- Meetings are scheduled by the meeting convener
- Meetings can be either virtual or face to face
 - Virtual meetings are typically 2 hours long
 - Face to face meetings are typically 2 days long
- Typically 3 meetings a year per working group

Approval & voting

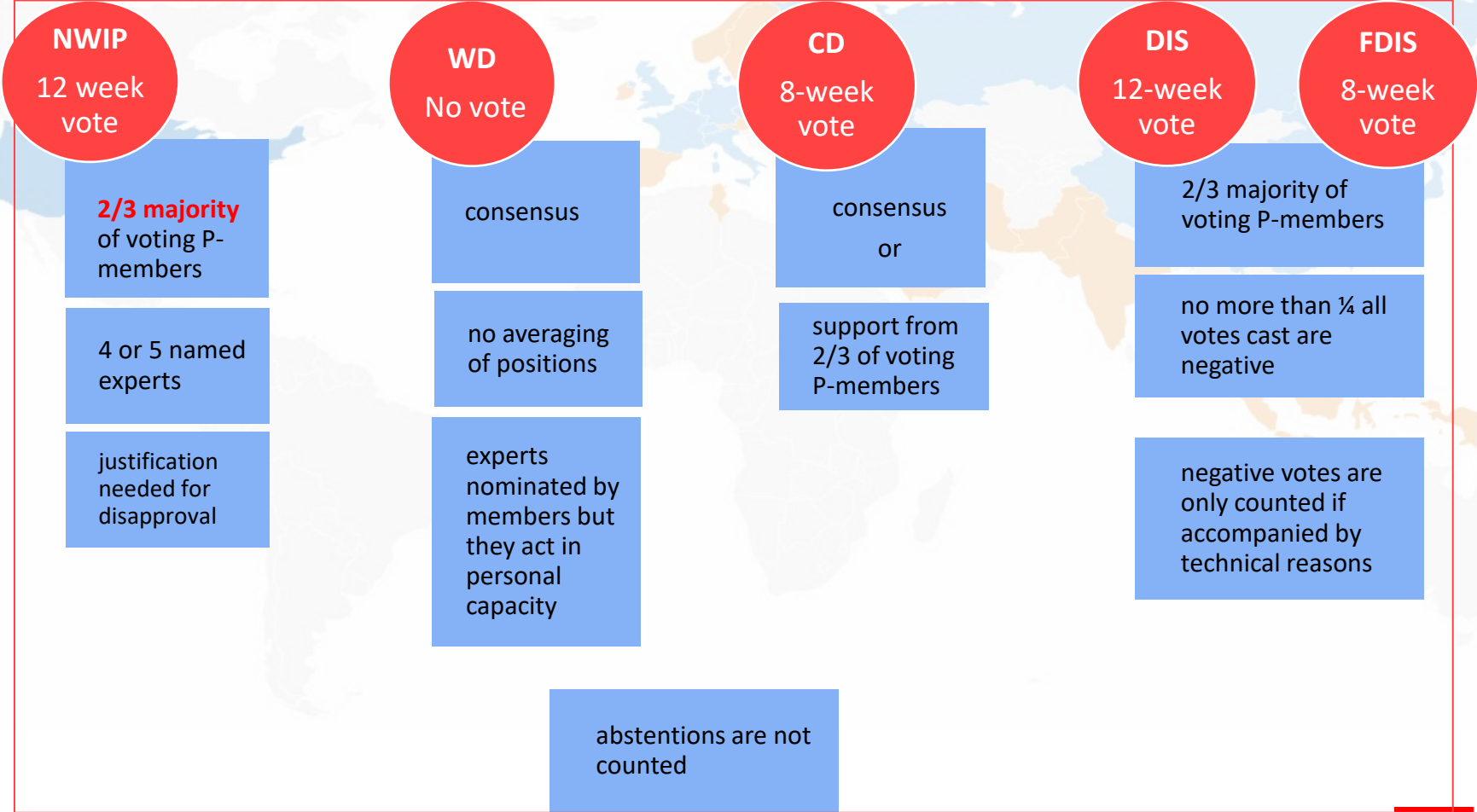

Document Development Stages

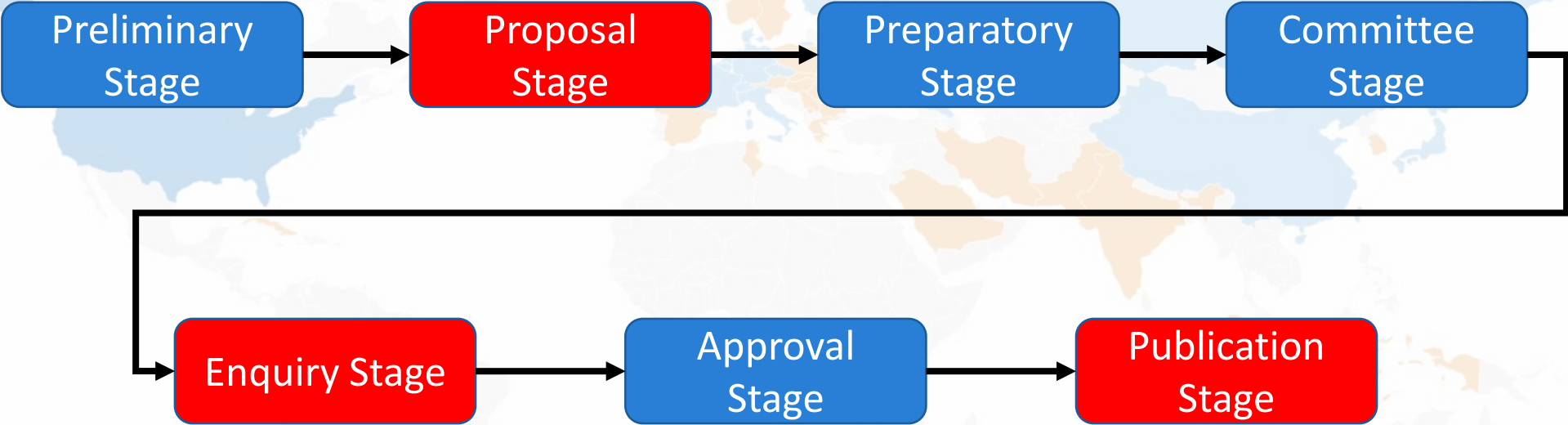

■ Mandatory

■ Optional



Systematic review

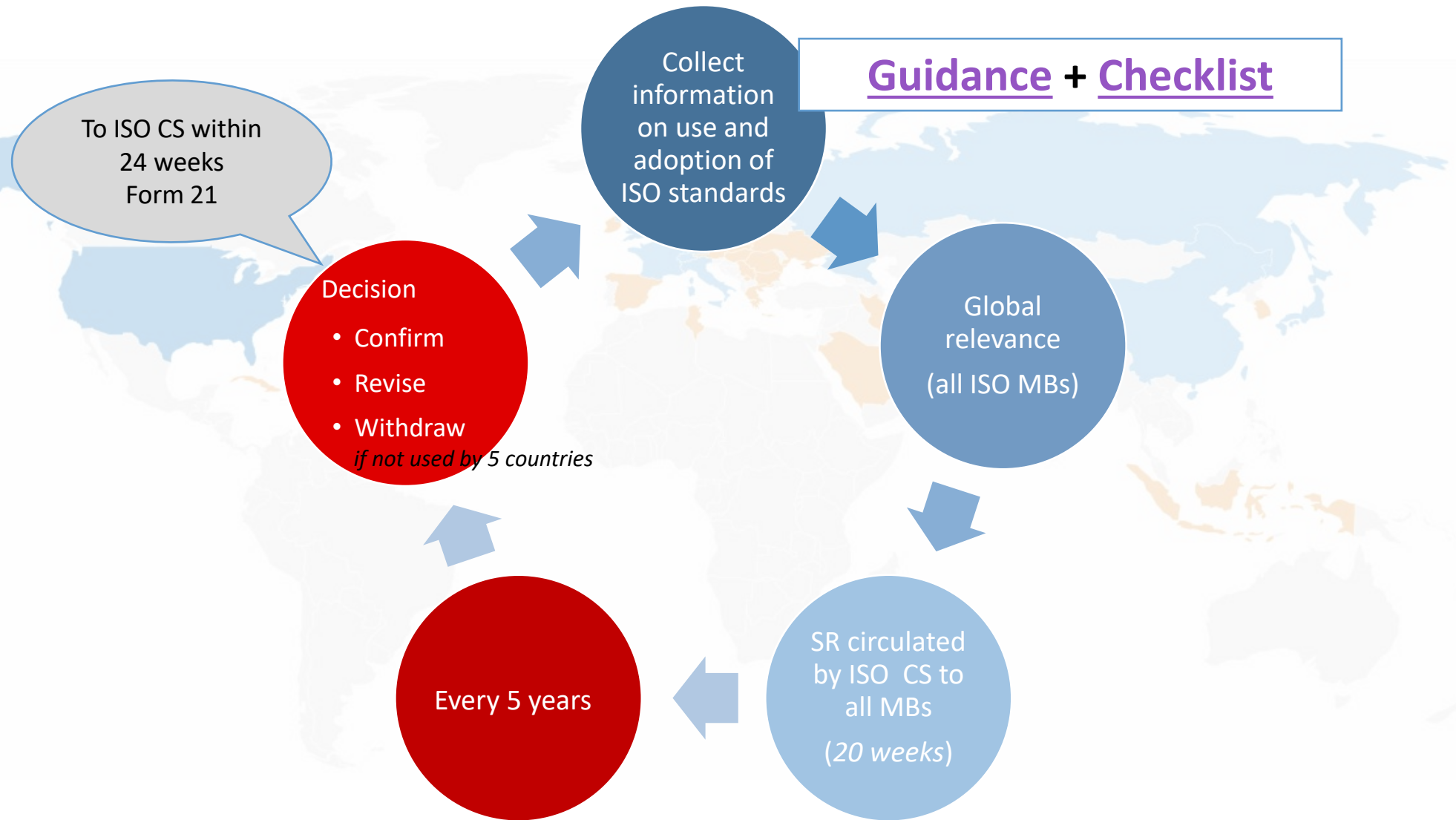

Monitored by ISO to measure Committee performance



More Information

- About ISO:
 - <https://www.iso.org/about-us.html>
- ISO directives and policies:
 - <https://www.iso.org/directives-and-policies.html>



THANK YOU

QUESTIONS?

